

Project Information	
Project Name:	Fixture Type:
Complete Catalog #:	Date:
Comments:	



The EnviroLux Amber Shoe Box is available with a wide choice of mounting configurations and optical distributions designed to replace HID lighting systems up to 400w. Typical area lighting applications include retail centers, industrial parks, airports, and office buildings, close to beaches where Amber environmental lighting codes apply. Mounting heights of 14 to 25 feet can be used based on light level and uniformity requirements

SPECIFICATIONS AND FEATURES:

EnviroLux LED Engine:
135 LPW, 600NM, Silicone Coated Aluminum Core Boards - Water and Humidity Proof

HOUSING:
Die Cast Aluminum Housing and Front Frame, Integral Heat Sinking and Driver Compartment. Photocell Adaptable. Nickel-Plated Stainless Steel Hardware.

WATTAGE:
78W=Array: 78 System Watts: Lumens:10,003 (100-175W HID or Induction Equivalent.)

FINISH:
Textured Architectural Bronze Powdercoat Finish Over a Chromate Conversion Coating. Custom Colors Available Upon Request.

DRIVER:
Programmable Driver, 120-277V, 50/60Hz; Dimmable Driver.

LENS:
Tempered Clear Flat Glass Lens or Tempered Clear Flat Prismatic Glass Lens.

LISTING & RATINGS:
CSA Listed for Wet Locations. Operating Temperatures: -40°C to + 50°C IP67 Sealed LED Compartment.

MOUNTING OPTIONS:
Mounts with Stealth Arm, Adjustable Slipfitter, 2 3/8" Diameter Mounting Arm Adapter, Yoke, Two-Piece Bracket or Easy Hang Wall Bracket (Factory Installed).

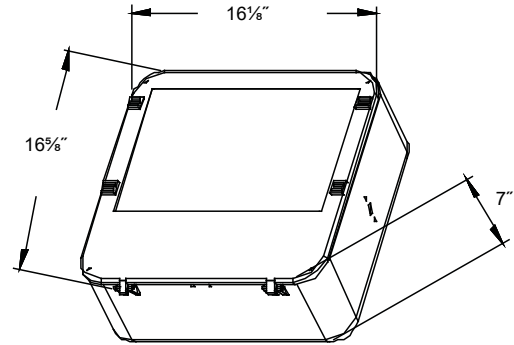

Complete Units Ordering Information Example: HE-ENV-78W-LED-LFL-AMBER-600NM-PS-UNV-ST

EnviroLux 600NM AMBER Shoebox



HE-ENV-78W-LED-LFL-AMBER-600NM-PS-UNV-ST

Scan to watch our Made in USA video

Model	Part Suffix	Driver	Wattage	CCT	Lens	Mounting	Options
HE	ENV-78W-LED-LFL-AMBER-600NM-PS-UNV-ST	U=120-277V	78	AMBER			

GL=Glare Shield

- STA=Stealth Arm
- SSF= Slipfitter
- ALMAA= Mounting Arm Adapter
- STY=Stealth Yoke
- SSB=Two-Piece Swivel Bracket
- KHEH=Easy-Hang Wall Bracket
- NM=No Mount

- UNIFI=EnviroLux Wireless
- GL=Glare Shield
- SF=Single Fuse
- DF=Double Fuse
- SP=Surge Protection
- M1=Motion Sensor, IR for mounting heights of 20ft to 35ft (Bi Level)
- M2=Motion Sensor, IR for mounting heights of 18ft or less (Bi Level)
- R3=3-Pin Twist Lock Photocell Receptacle
- R7=7-Pin ANSI C136.41—2013 Twist Lock Photocell Receptacle with P18132 shunting cap
- 480v=480 Volt



EnviroLux Large Flood Light Mounting, Accessories and EPA

ADDITIONAL OPTIONS:



Glare Shield (GS)
(Shown Mounted)



Wireguard (WG)
(Shown Mounted)

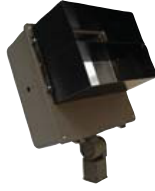

Baffle (BF)
(Shown Mounted)

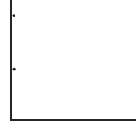

Vandal Shield (VS)



6" Mounting Arm
(MA6)
(MA10)
(MA12)
(MA18)



Slip Fitter (SF)



Swivel Bracket (SB)





Yoke (Y)





Adjustable Mount (AM)

EPA (EFFECTIVE PROJECTED AREA) SHOWN with Large Flood Straight ARM MOUNTING

Configuration	EPA (Sq. Ft.)	Weight (Lbs.)
 1	0.60	15 Lbs

Configuration	EPA (Sq. Ft.)	Weight (Lbs.)
 2@180° Mount	1.20	30 Lbs
 2@90° Mount	0.82	30 Lbs

Configuration	EPA (Sq. Ft.)	Weight (Lbs.)
 3@90° Mount	1.32	45 Lbs
 3@120° Mount	1.20	45 Lbs

Configuration	EPA (Sq. Ft.)	Weight (Lbs.)
 4@90° Mount	1.32	60 Lbs



Mounting Accessories (Order separately, Field installed)	
EES20RPZ	Die-Cast Adaptor for 3" to 4" Round Poles, Bronze Powdercoat Finish. Use with Stealth Mounting Arm only.
EES20WMZ	Die-Cast Wall Mount Adaptor, Bronze Powdercoat Finish. Use with STA Kitty Stealth Mounting Arm only.
EESPTSB1SZ	Single Pole Tenon Spoke Bracket, 2 3/4" Horizontal Mounting Arm, Bronze Powdercoat Finish, Includes Hardware.
EESPTSB290SZ	Twin Pole Tenon Spoke Bracket, 2 3/4" Horizontal 90° Mounting Arms, Bronze Powdercoat Finish, Includes Hardware.
EESPTSB2180-SZ	Twin Pole Tenon Spoke Bracket, 2 3/4" Horizontal 180° Mounting Arms, Bronze Powdercoat Finish, Includes Hardware.
EES-PTSB 390SZ*	Triple Pole Tenon Spoke Bracket, 2 3/4" Horizontal 90° Mounting Arms, Bronze Powdercoat Finish, Includes Hardware.
EESPTSB3120-SZ	Triple Pole Tenon Spoke Bracket, 2 3/4" Horizontal 120° Mounting Arms, Bronze Powdercoat Finish, Includes Hardware.
EESPTSB490SZ*	Quad Pole Tenon Spoke Bracket, 2 3/4" Horizontal 90° Mounting Arms, Bronze Powdercoat Finish, Includes Hardware.

*Special order item. Lead time three weeks.

Accessories (Order separately, Field installed)	
EES-P18140	110-120VAC Instant Twist Lock Photocell
EES-P18142	110-277VAC Instant Twist Lock Photocell
EES-P18150	120VAC Time Delay Twist Lock Photocell
EES-P18152	277VAC Time Delay Twist Lock Photocell
EES-P18131	Twist Lock Non-Shorting (Open) Cap Disconnects Service to Fixture for Temporary or Permanent Disabling (Fixture Always Off). IP65, 480V Maximum.
EESP18132	Twist Lock Shorting Cap Provides Fixed Service to Fixture (Fixture Always on). IP65, Rated Load 7200w Tungsten.
EES-ACCHS G1Z	Die Cast Accessory Housing for Installing Sensors or Other Lighting Control, Bronze Powdercoat Finish.
EES25GSZ	Aluminum House Side Shield, Bronze Powdercoat Finish, Includes Hardware.

Replacement Parts (Order separately, Field installed)	
EES-STGL	Tempered Clear Flat Glass Lens.
EES-STGLP	Tempered Prismatic Flat Glass Lens.
EES-AZ	Stealth Die-Cast Mounting Arm, Bronze Powdercoat Finish, Includes Hardware. Mounts Directly to Square Poles.
EES-SSFZ	External Mount Die-Cast Adjustable Slipfitter for 2 3/4" Tenons, Bronze Powdercoat Finish, Includes Hardware.
EESALMAAZ	Die-Cast Adaptor for 2 3/4" Horizontal Mounting Arms, Bronze Powdercoat Finish, Includes Hardware.
EES-STYZ	Stamped Heavy-Duty Steel Yoke, Bronze Powdercoat Finish, Includes Hardware.
EES-SSBZ	Two-Piece Stamped Steel Adjustable Bracket, Bronze Powdercoat Finish, Includes Hardware.
EES-EHZ	Die-Cast Easy-Hang Wall Bracket, Bronze Powdercoat Finish, Includes Hardware.

