

<b>Project Information</b>	
Project Name:	Fixture Type:
Complete Catalog #:	Date:
Comments:	

The EnviroLux Roundback Flood is available with a wide choice of mounting configurations designed to replace HID lighting systems from 100w to 250w. Typical area lighting applications include retail centers, industrial parks, airports, and office buildings, close to beaches where Amber environmental lighting codes apply. Mounting heights of 14 to 25 feet can be used based on light level and uniformity requirements.

**Specifications and Features:**

**Housing:**  
Die-Cast Aluminum Housing & Hinged Gasketed Lens Frame. Nickel-Plated Stainless Steel Hardware.

**Finish:**  
Textured Architectural Bronze Powdercoat Finish Over a Chromate Conversion Coating. Custom Colors Available Upon Request.

**Lens:**  
Tempered Clear Flat Glass Lens or Tempered Clear Flat Prismatic Glass Lens.

**Mounting Options:**  
Adjustable Knuckle with Angle Indicators & 1/2" NPS Threads or Optional Adjustable Slipfitter with Angle Indicators.

**EnviroLux LED Engine:**  
201 LPW, 83CRI, Silicone Coated Aluminum Core Boards - Water and Humidity Proof

**Wattage:**  
45W=Array: 45 System Watts: **Lumens:8,592** (150-250W HID or Induction Equivalent.)

**Driver:**  
Programmable Driver, 120-277V, 50/60Hz; Dimmable Driver.

**Listing & Ratings:**  
CSA Listed for Wet Locations.  
Operating Temperatures: -40°C to + 55°C IP67  
Sealed LED Compartment.



Shown with "KZ" Knuckle Mounting Option.

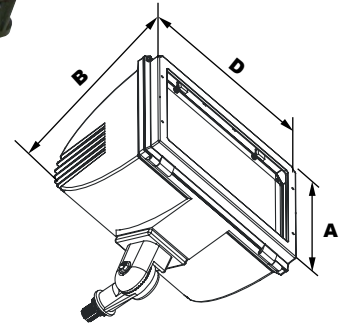

**Dimensions**





- Width (D)** | 11" (279mm)
- Length (B)** | 8" (203mm)
- Height (A)** | 8 1/2" (216mm)

Complete DLC Model  
Number: HE-ENV-45W-LED-  
RBF-50K-PS-UNV

**EnviroLux High Lumen 45 Watt LED Roundback Flood**



Scan to watch our Made in USA video

HE-ENV							
Model	Part Suffix	Driver	Wattage	CCT	Lens	Mounting	Options
EESFL65	LED-RBF	UNV=120-277V	45W	AMBER 2700K 3000K 3500K 4000K 5000K  CL=Clear			
 <p>EnviroLux Unifi Mesh Passport can operate up to 500 fixtures on a wireless network from anywhere in the world.</p>				<p><b>KN</b>=Knuckle <b>Swivel Bracket</b>= SB <b>Slipfitter</b>=SF <b>PTFZ</b>=Post Top <b>RBFKZ</b>=Adjustable Knuckle <b>RBFVS</b>=Vandal Shield <b>STK</b>=Heavy Duty Ground Stake</p> <p><b>SF</b>=Single Fuse <b>DF</b>=Double Fuse <b>SP</b>=Surge Protection <b>M1</b>=Motion Sensor, IR for mounting heights of 20ft to 35ft <b>M2</b>=Motion Sensor, IR for mounting heights of 18ft or less <b>Photocell</b>: PC <b>In-Line Fuse</b>: F <b>RBFWG</b>=Wire Guard <b>RBFGSZ</b>=Glare Shield <b>UNIFI</b>=EnviroLux Unifi</p>			
   							

# EnviroLux Round Back Flood

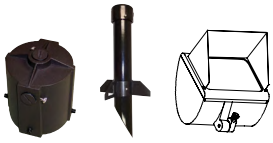

**PTFZ STK RBFGSZ\***

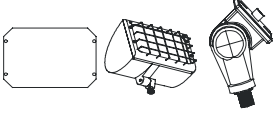

**RBFVS RBFWG\* RBFKZ**



**SF**

Mounting Accessories (Order separately, Field installed)		Accessories (Order separately, Field installed)		Replacement Parts (Order separately, Field installed)	
PTFZ	Die-cast Post Top Fitter for 2¾" to 3½" Poles, Bronze Powdercoat Finish, Three (3) ½" Coin Plugs.	RBFGSZ	Glare Shield, Aluminum, Bronze Powdercoat Finish, Includes Hardware.	RBFGL	Tempered Clear Flat Glass Lens.
STK	Heavy Duty Ground Stake, Built-in Wiring Compartment with ½" NPS Threaded Fitting, Black Plastic.	RBFVS	Clear Polycarbonate Vandal Resistant Guard, Includes Hardware.	RBFGLP	Tempered Prismatic Flat Glass Lens.
		RBFWG	Wire Guard, Stainless Steel, Includes Hardware.	RBFKZ	Die-Cast Adjustable Knuckle with ½" NPS Threads, Bronze Powdercoat Finish.
				SF	External Mount Die-Cast Adjustable Slipfitter for 2¾" Tenons, Bronze Powdercoat Finish, Includes Hardware.